

ALCANCE N° 227

REGLAMENTOS

INSTITUTO COSTARRICENSE DE ACUEDUCTOS Y ALCANTARILLADOS

TOMO V

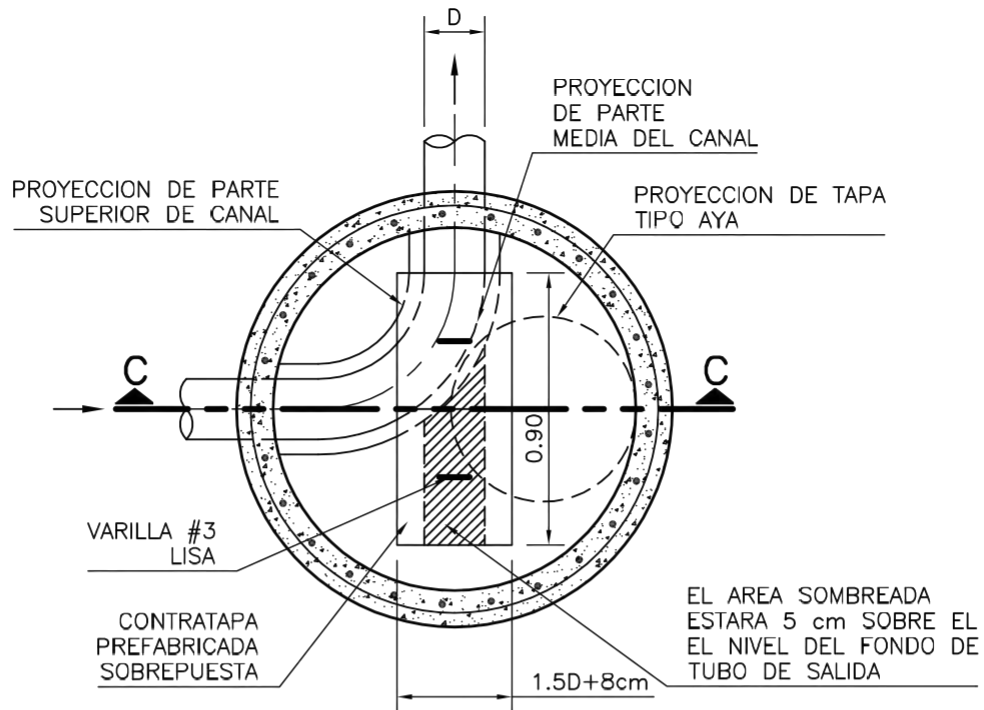

PLANTA

D= DIAMETRO DE TUBERIA DE SALIDA

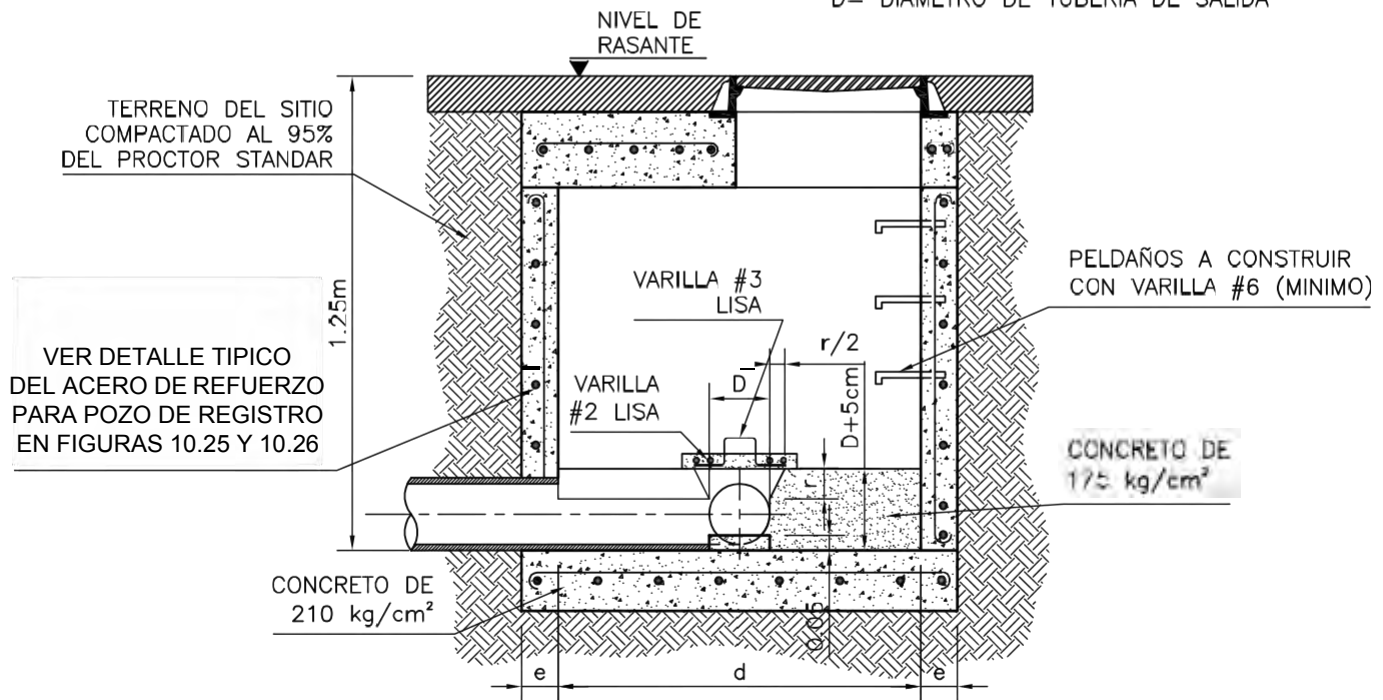

SECCION C-C



INSTITUTO COSTARRICENSE DE
ACUEDUCTOS Y ALCANTARILLADOS
UN PROGRAMACION Y CONTROL

DETALLE DE POZO DE
REGISTRO SANITARIO TIPO C

ESCALA 1:25

2017

FIGURA 10.14

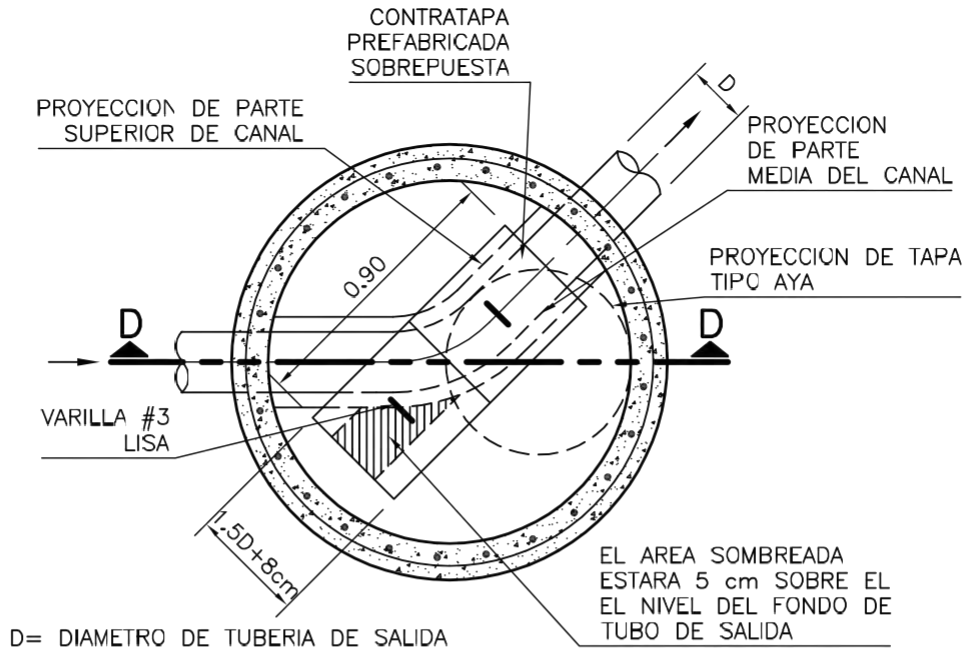

PLANTA

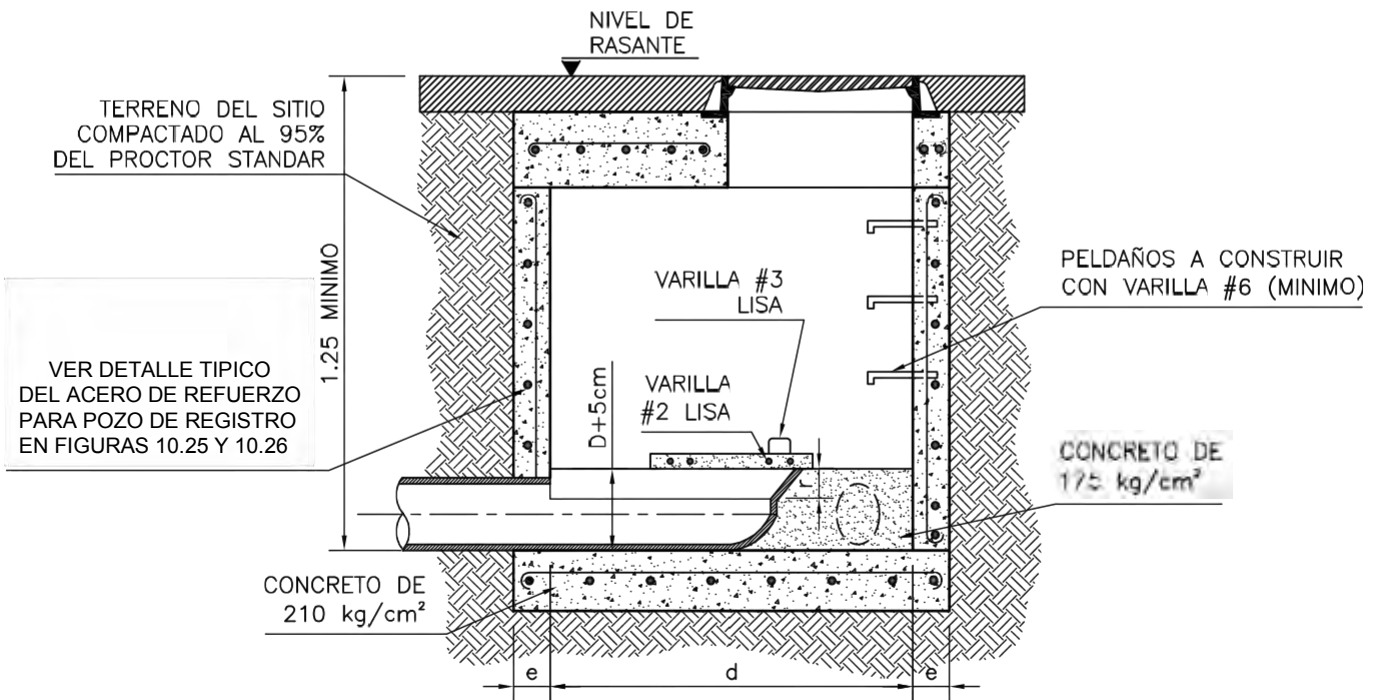

SECCION D-D



INSTITUTO COSTARRICENSE DE
ACUEDUCTOS Y ALCANTARILLADOS
UNEN PROGRAMACION Y CONTROL

DETALLE DE POZO DE
REGISTRO SANITARIO TIPO D

ESCALA 1:25

2017

FIGURA 10.15

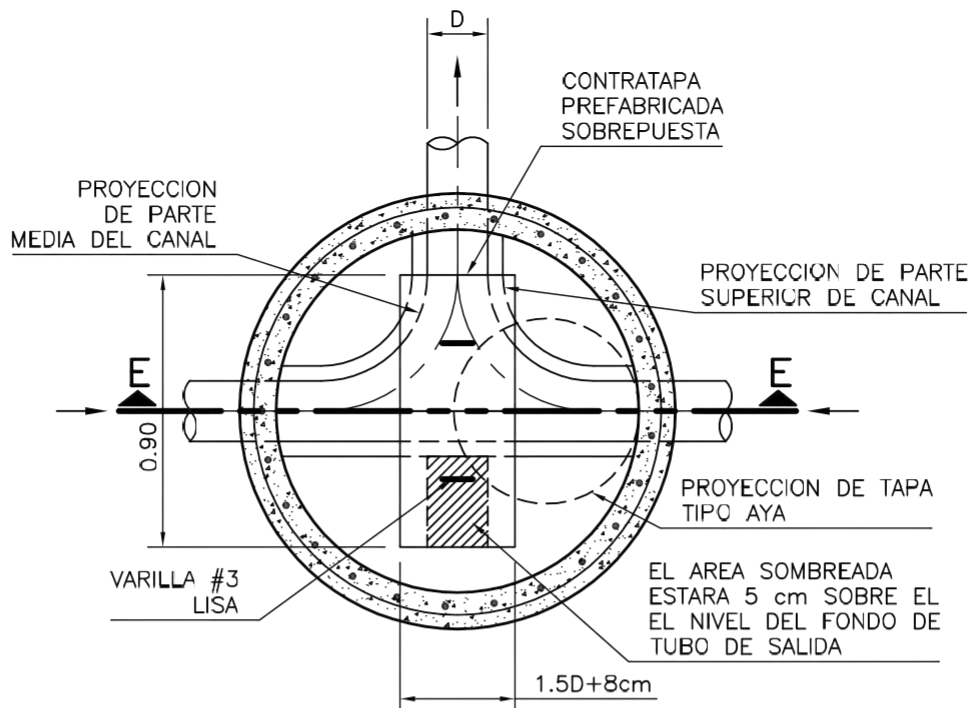

PLANTA D= DIAMETRO DE TUBERIA DE SALIDA

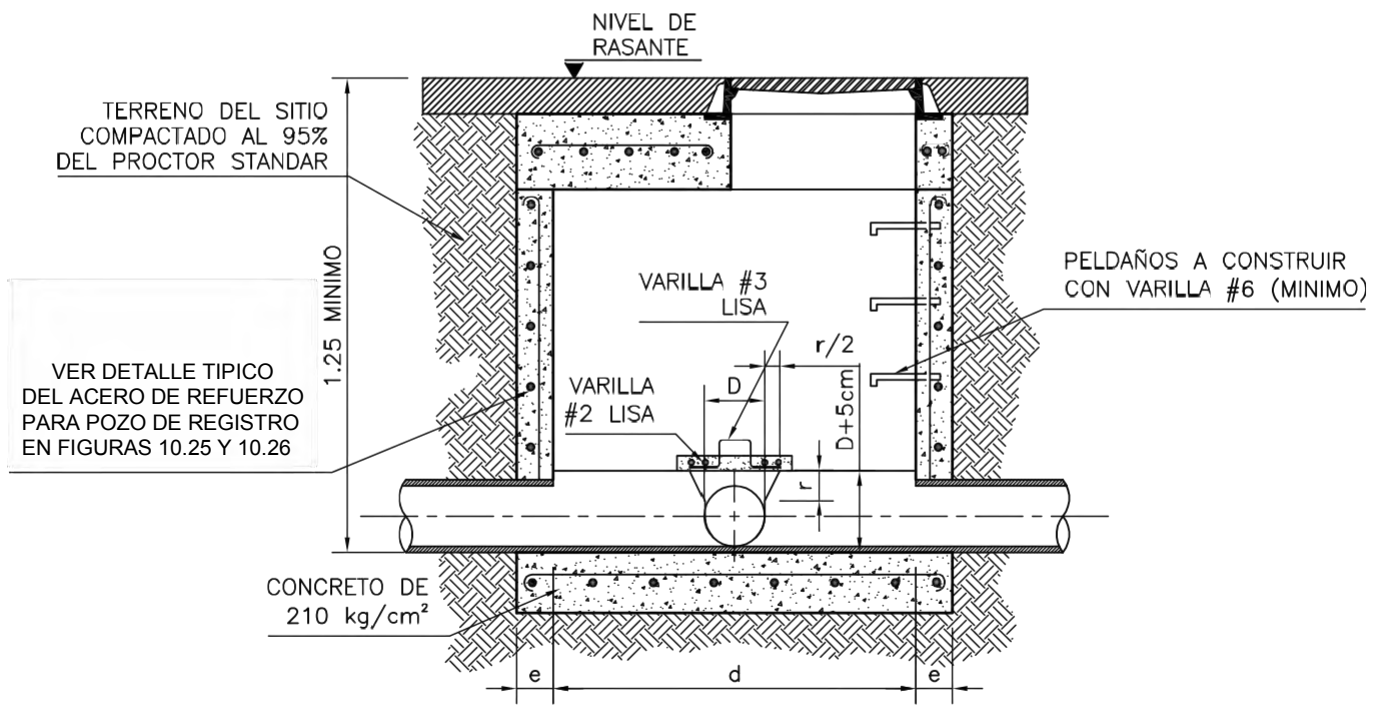

SECCION E-E



INSTITUTO COSTARRICENSE DE
ACUEDUCTOS Y ALCANTARILLADOS
UNEN PROGRAMACION Y CONTROL

DETALLE DE POZO DE
REGISTRO SANITARIO TIPO E

ESCALA 1:25

2017

FIGURA 10.16

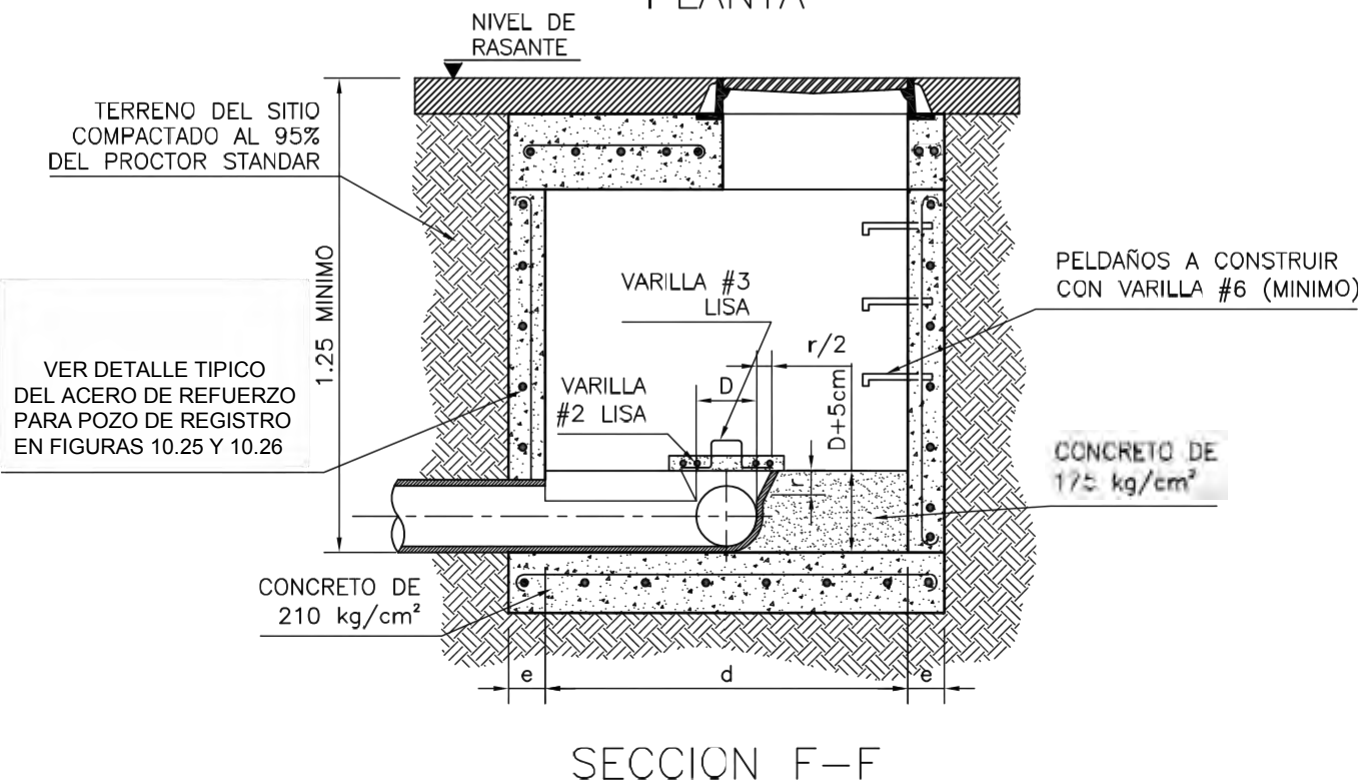
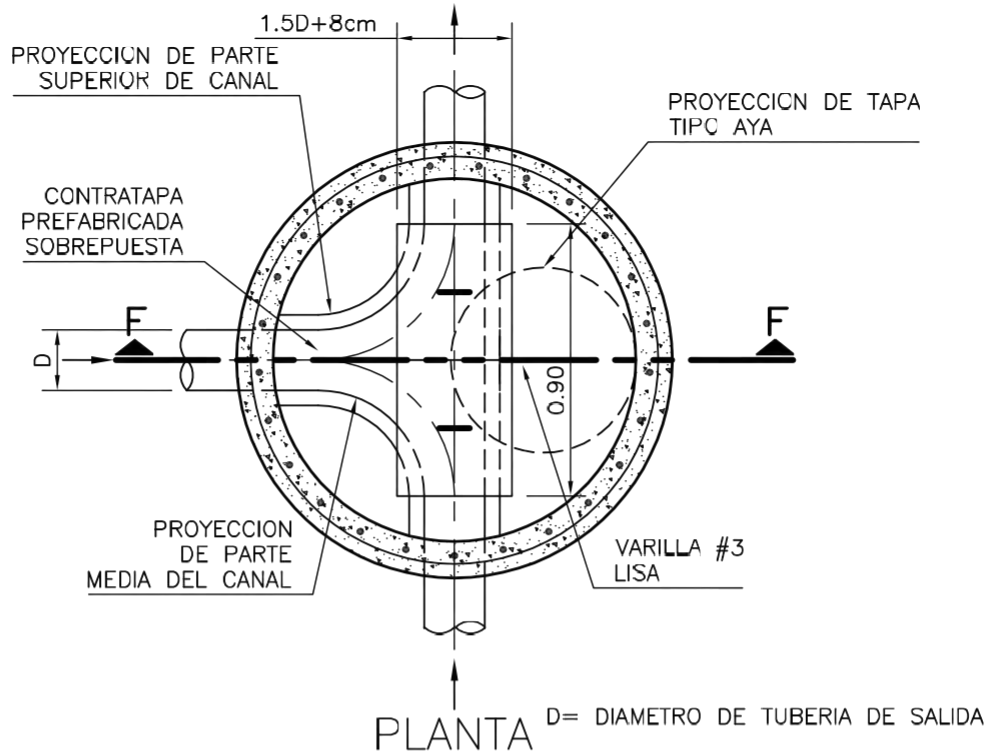

SECCION F-F



INSTITUTO COSTARRICENSE DE
ACUEDUCTOS Y ALCANTARILLADOS
UNEN PROGRAMACION Y CONTROL

DETALLE DE POZO DE
REGISTRO SANITARIO TIPO F

ESCALA 1:25	2017	FIGURA 10.17
-------------	------	--------------